

FRONT ELEVATION

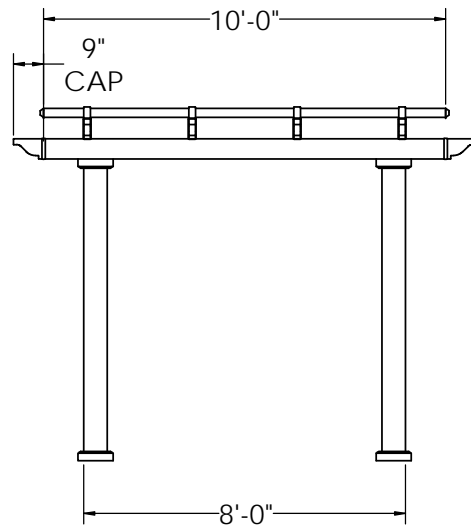

Post on Center Measurement

5" Square Post	91"
7" Square Column	85 1/2"
7" Round Column	85 1/2"
10" Round Column	83 3/4"

SIDE ELEVATION

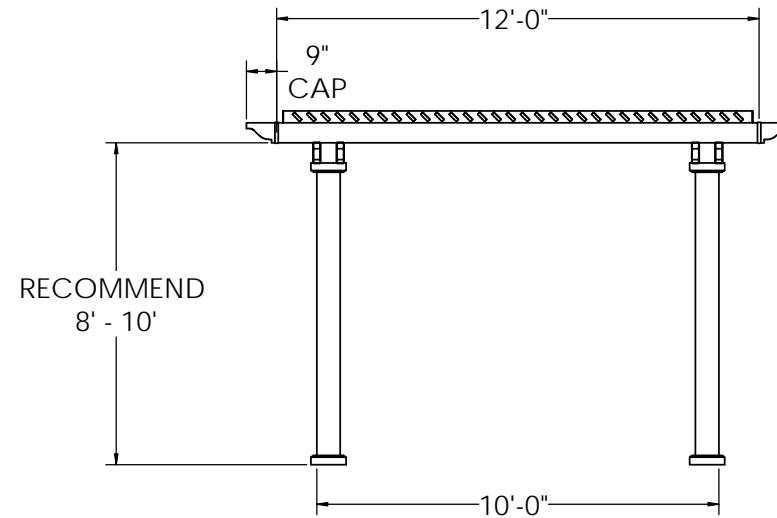

Center of Post to Structure Measurement

5" Square Post	115"
7" Square Column	109 1/2"
7" Round Column	109 1/2"
10" Round Column	107 3/4"

PLAN VIEW

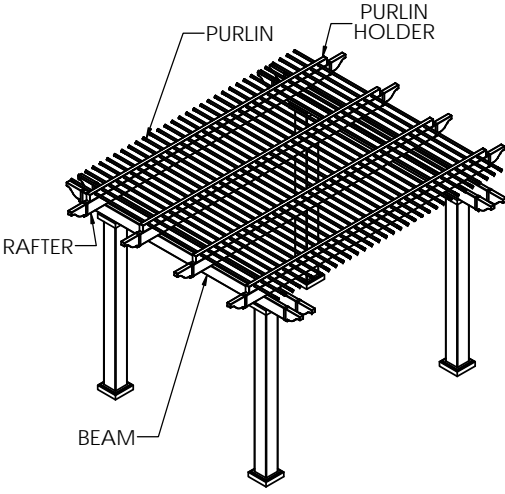
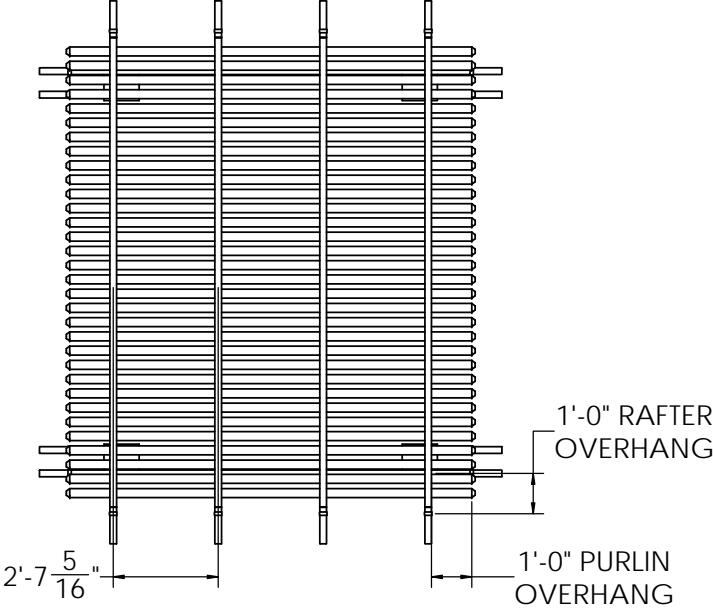

STRUCURAL COMPONENTS

DESCRIPTION	QTY.
7" COLUMN ASSY WITH POST MOUNT	4
2 x 6 BEAM WITH ALUMINUM INSERT	4
2 x 6 RAFTER WITH ALUMINUM INSERT	4
2 x 6 PERGOLA CAP	16
2 x 3 1/2 PURLIN HOLDER	4
2 x 3 1/2 FLAT CAP	8
7/8 x 3 PURLIN (STD SPACING)	32
7/8 x3 PURLIN CAP (STD SPACING)	64