

## FRONT ELEVATION

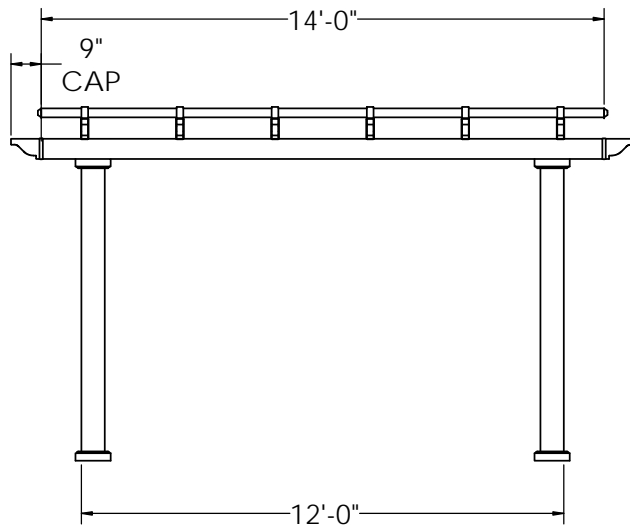

### Post on Center Measurement

5" Square Post	139"
7" Square Column	133 1/2"
7" Round Column	133 1/2"
10" Round Column	131 3/4"

## SIDE ELEVATION

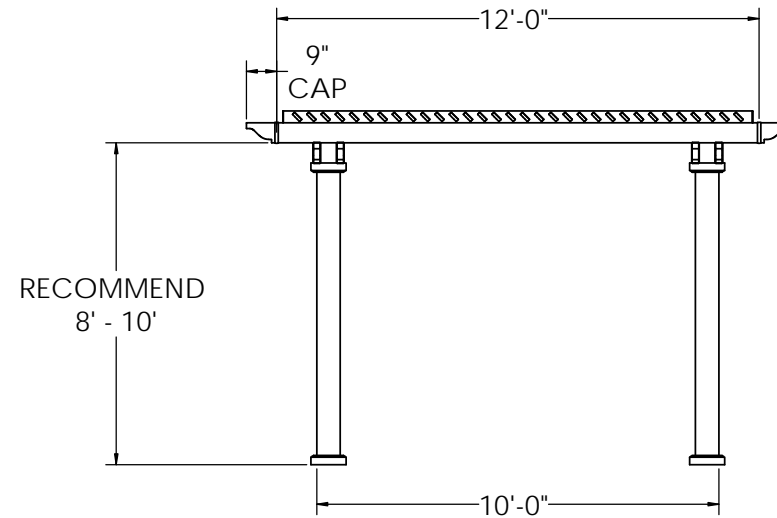

### Center of Post to Structure Measurement

5" Square Post	115"
7" Square Column	109 1/2"
7" Round Column	109 1/2"
10" Round Column	107 3/4"

# PLAN VIEW

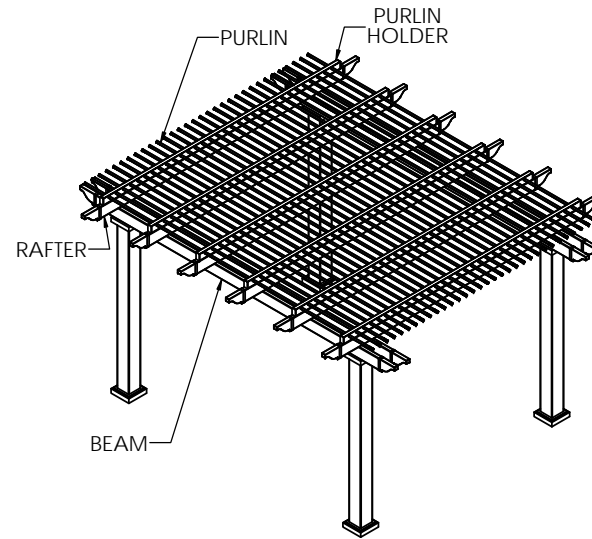
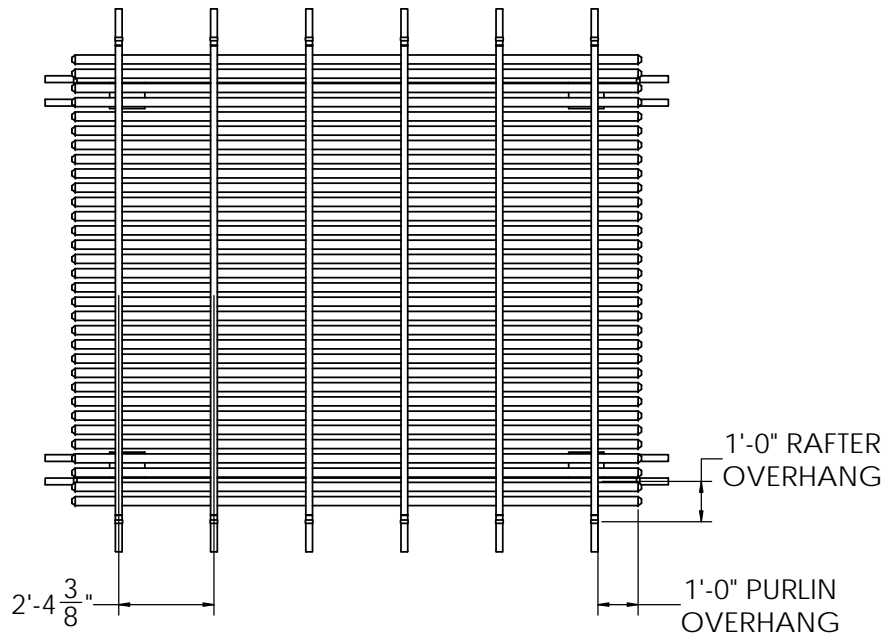

### STRUCTURAL COMPONENTS

DESCRIPTION	QTY.
7" COLUMN ASSY WITH POST MOUNT	4
2 x 6 BEAM WITH ALUMINUM INSERT	4
2 x 6 RAFTER WITH ALUMINUM INSERT	6
2 x 6 PERGOLA CAP	20
2 x 3 1/2 PURLIN HOLDER	6
2 x 3 1/2 FLAT CAP	12
7/8 x 3 PURLIN (STD SPACING)	32
7/8 x 3 PURLIN CAP (STD SPACING)	64

12' x 14' FREESTANDING PERGOLA

Heartlandpergolas.com

563-345-6745

