

FRONT ELEVATION

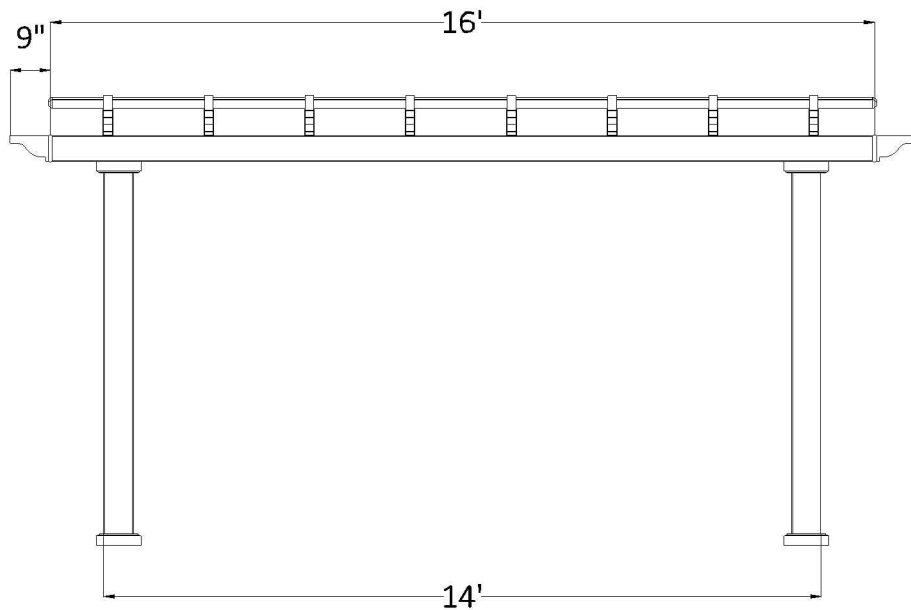

Post on Center Measurement

5" Square Post	163"
7" Square Column	157 1/2"
8" Round Column	157 1/2"
10" Round Column	155 3/4"

SIDE ELEVATION

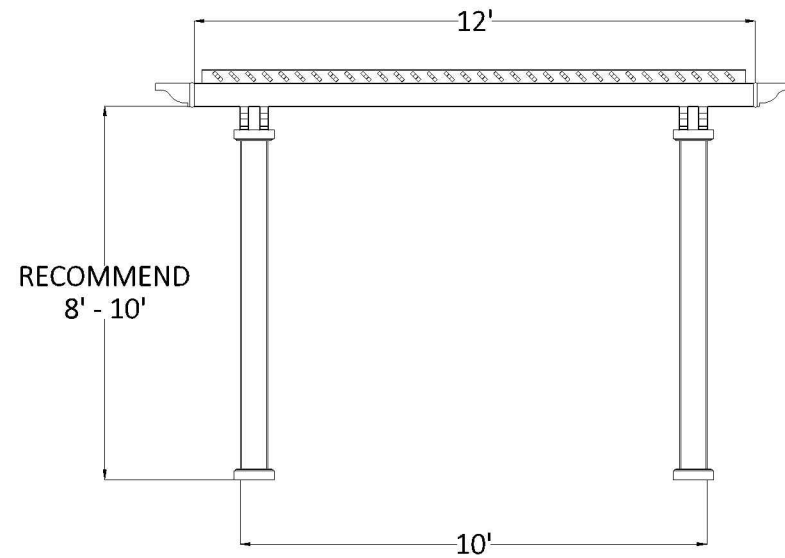

Center of Post to Structure Measurement

5" Square Post	127"
7" Square Column	121 1/2"
7" Round Column	121 1/2"
10" Round Column	119 3/4"

PLAN VIEW

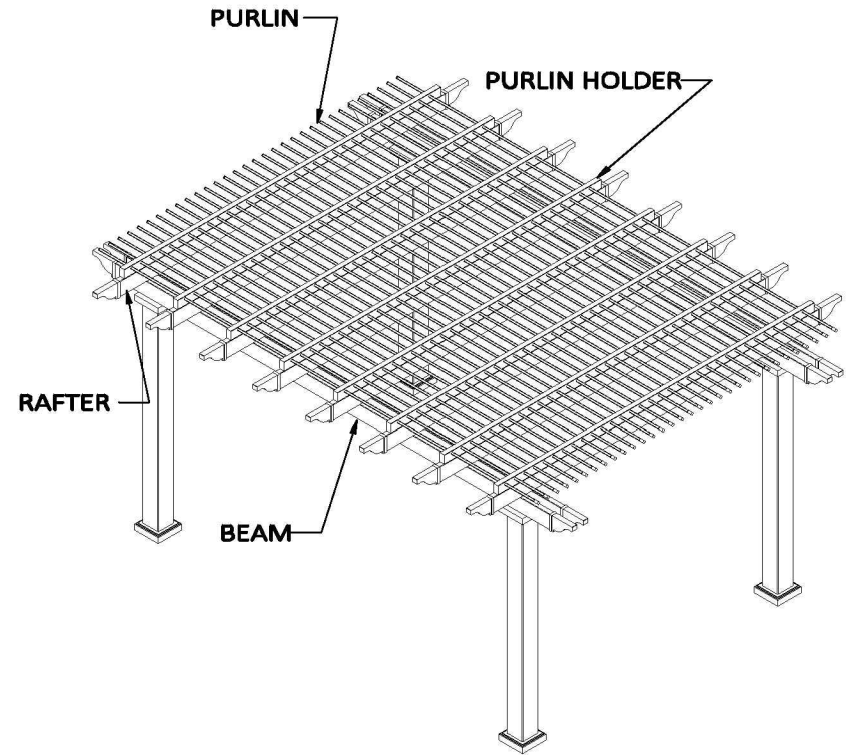
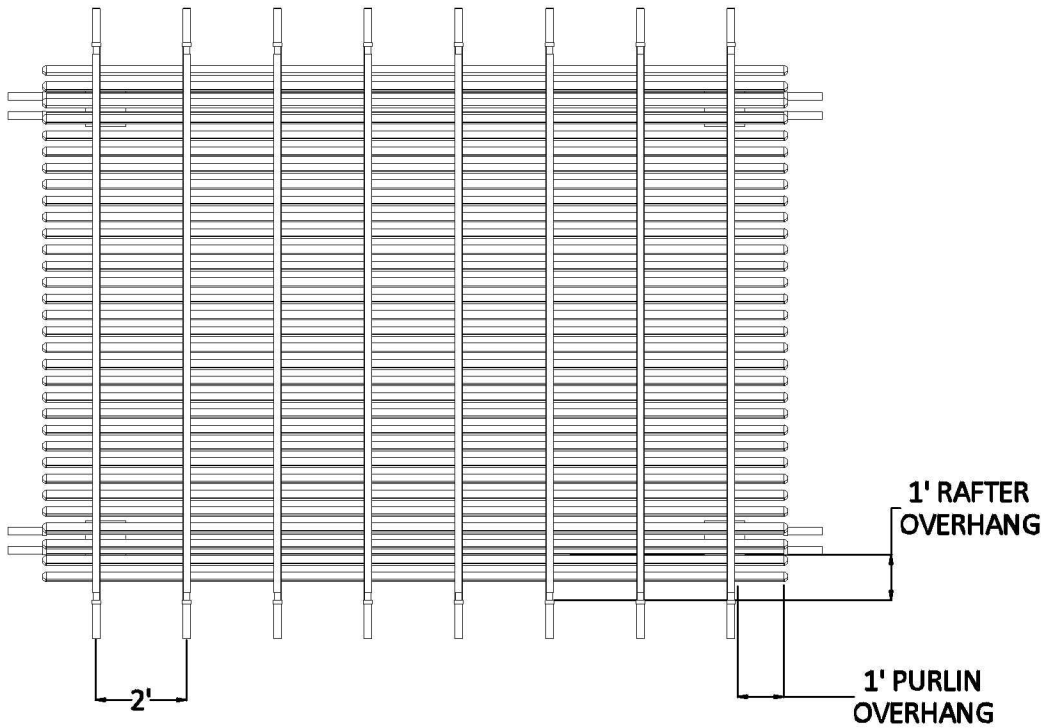

STRUCTURAL COMPONENTS

DESCRIPTION	QTY.
7" COLUMN ASSEMBLY W POST MOUNT	4
2 X 6 BEAM WITH ALUMINUM INSERT	4
2 X 6 RAFTER WITH ALUMINUM INSERT	8
2 X 6 PERGOLA CAP	24
2 X 3 1/2 PURLIN HOLDER	8
2 X 3 1/2 FLAT CAP	16
7/8 X 3 PURLIN (STD SPACING)	32
7/8 X 3 PURLIN CAP	64