

FRONT ELEVATION

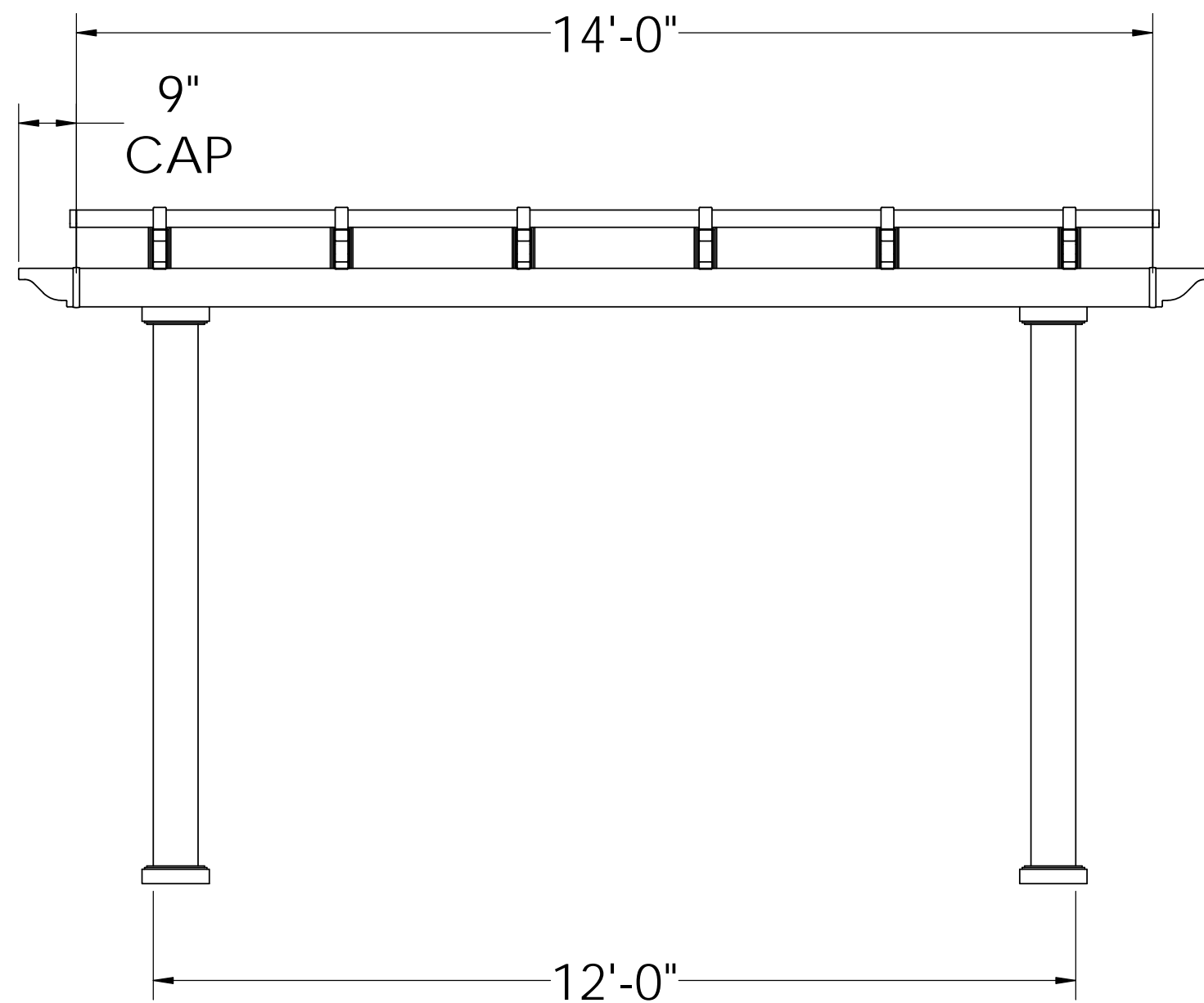

Post on Center Measurement

5" Square Post	139"
7" Square Column	133 1/2"
7" Round Column	133 1/2"
10" Round Column	131 3/4"

SIDE ELEVATION

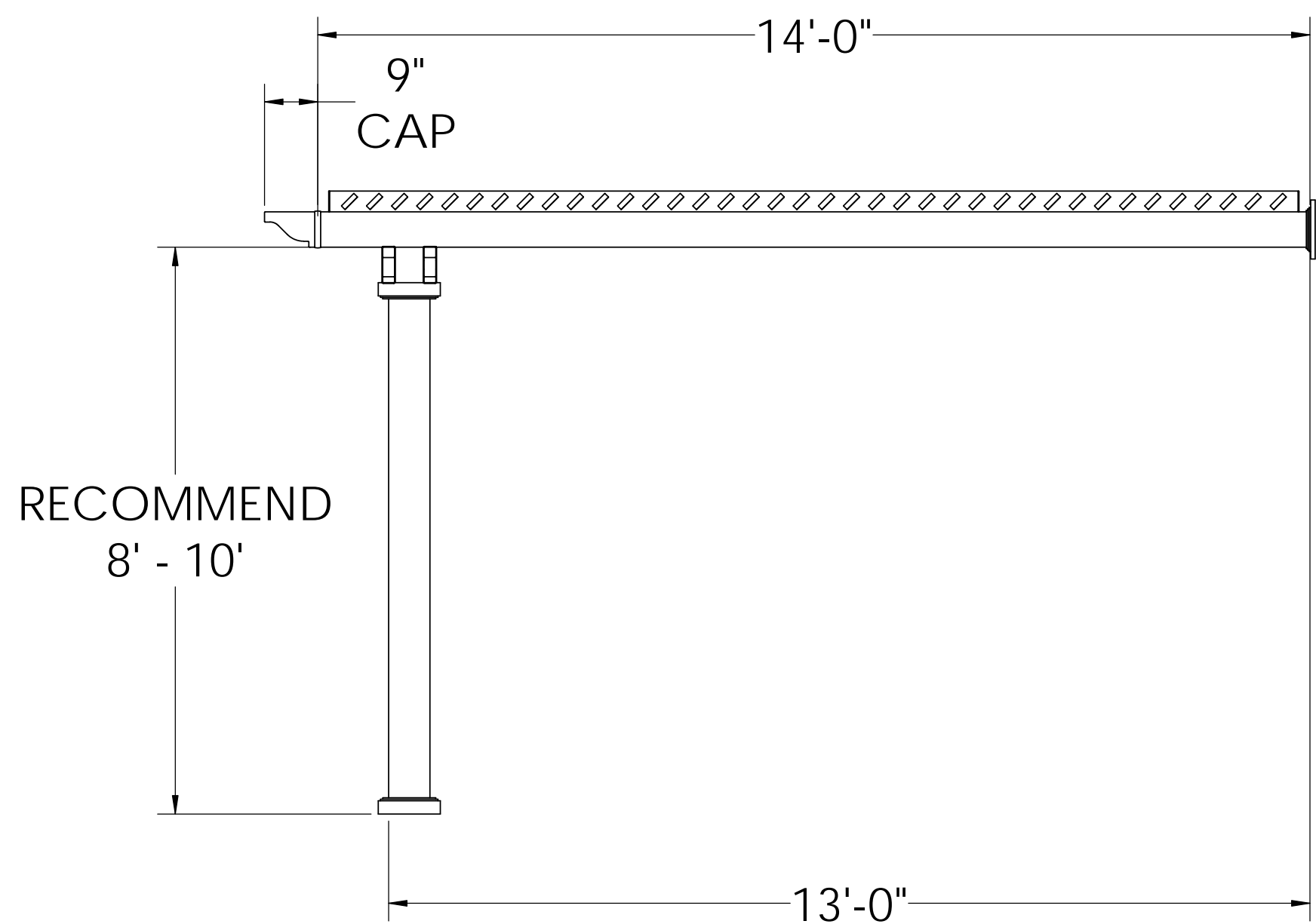

Center of Post to Structure Measurement

5" Square Post	153 1/2"
7" Square Column	150 3/4"
7" Round Column	150 3/4"
10" Round Column	149 7/8"

PLAN VIEW

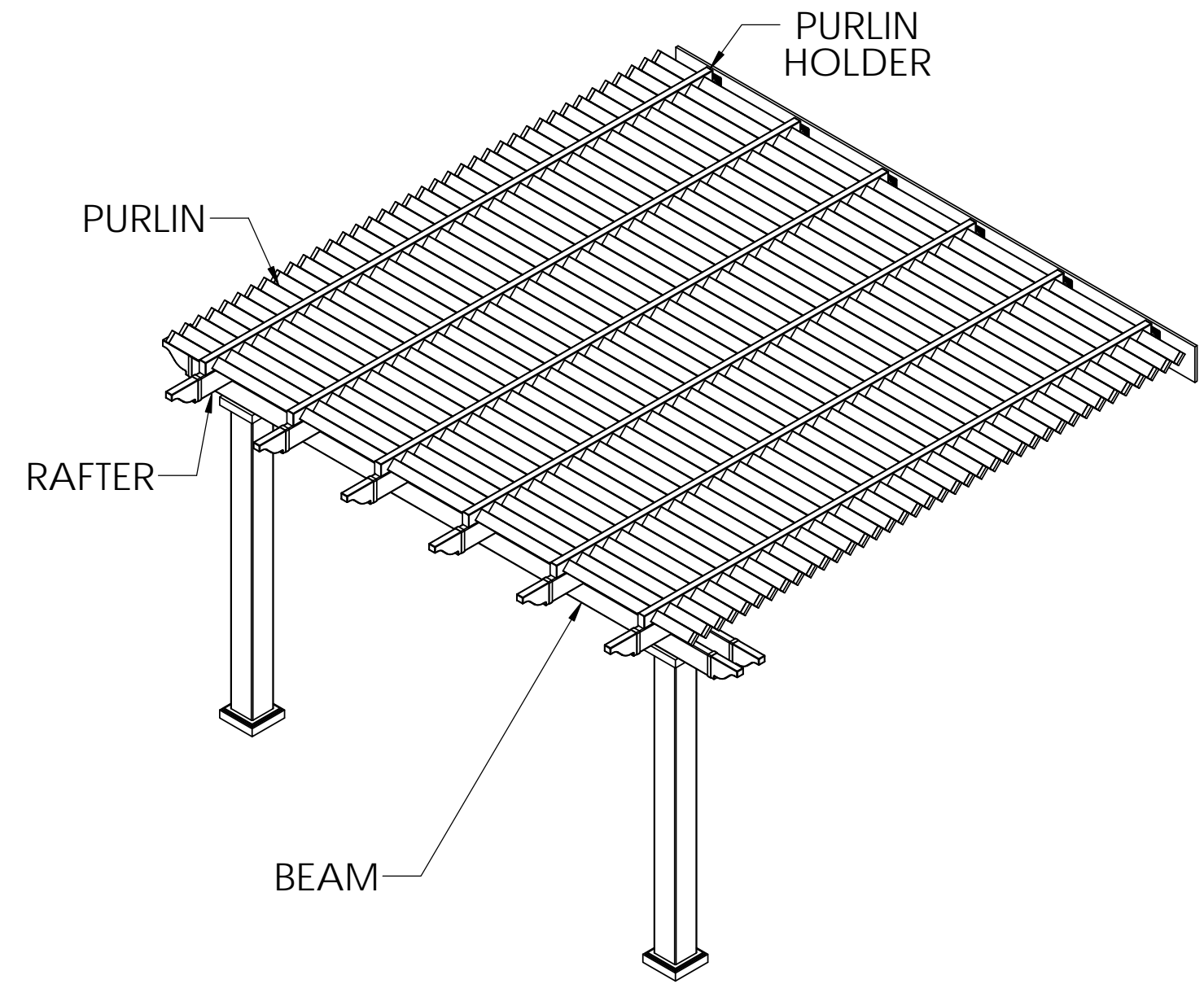
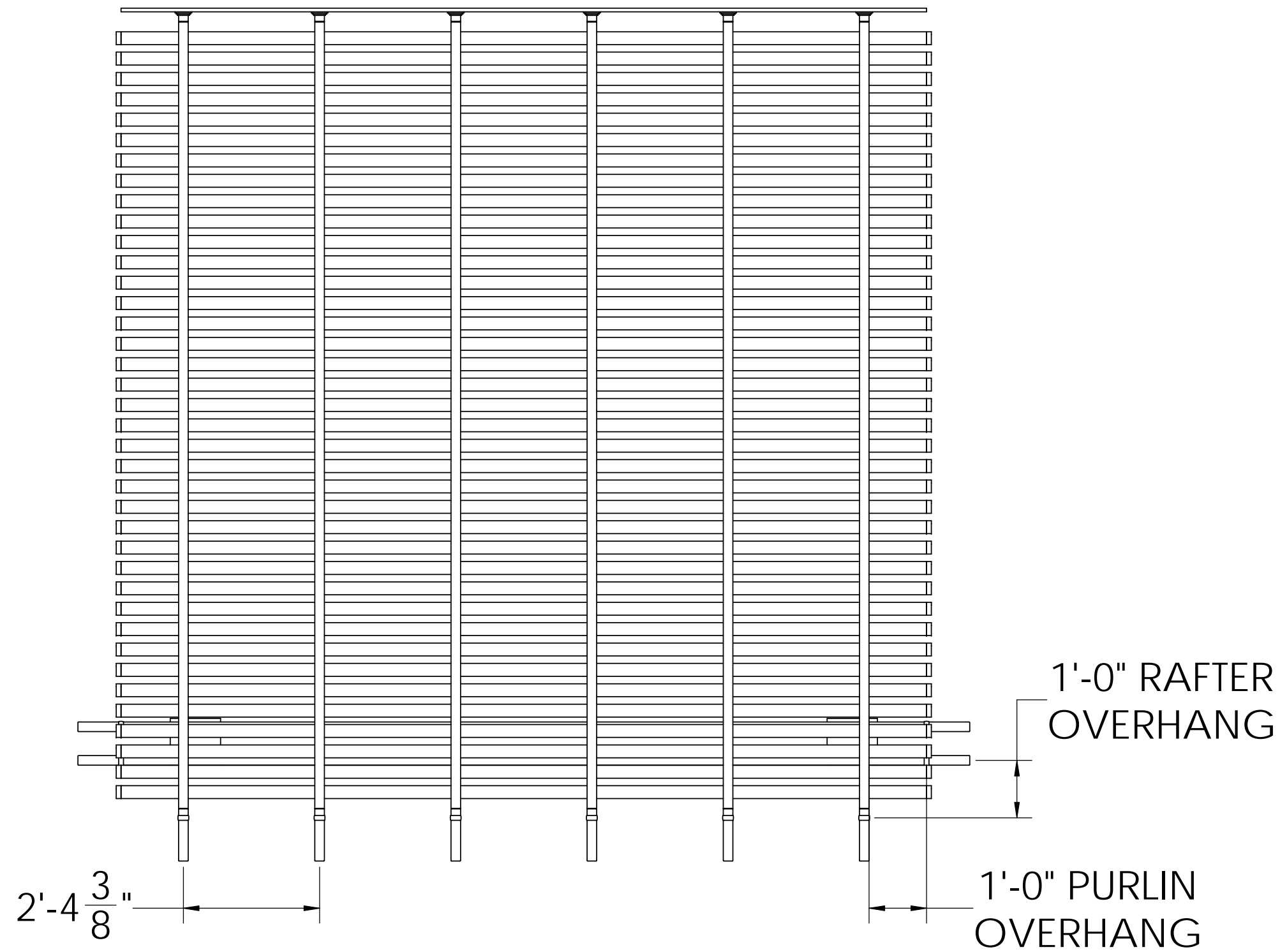

STRUCTURAL COMPONENTS

DESCRIPTION	QTY.
7" COLUMN ASSY WITH POST MOUNT	2
2x6 BEAM WITH ALUMINUM INSERT	2
2x6 RAFTER WITH ALUMINUM INSERT	6
2 x 6 PERGOLA CAP	10
RAFTER HANGER WITH COVER	6
2 x 3 1/2 PURLIN HOLDER	6
2 x 3 1/2 FLAT CAP	12
7/8 x 3 PURLIN (STD SPACING)	38
7/8 x 3 PURLIN CAP (STD SPACING)	76
PVC LEDGER PLATE	1

14' x 14' ATTACHED PERGOLA

Heartlandpergolas.com

563-345-6745

