

FRONT ELEVATION

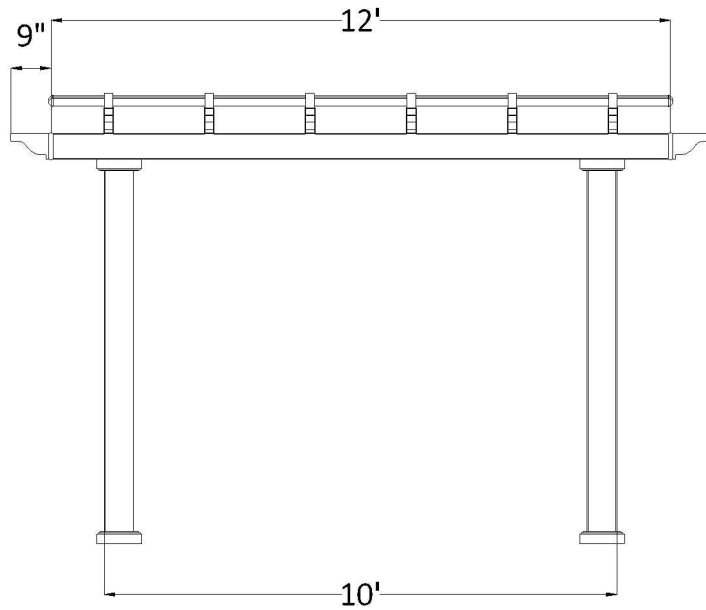

Post on Center Measurement

5" Square Post	115"
7" Square Column	109 1/2"
7" Round Column	109 1/2"
10" Round Column	107 3/4"

SIDE ELEVATION

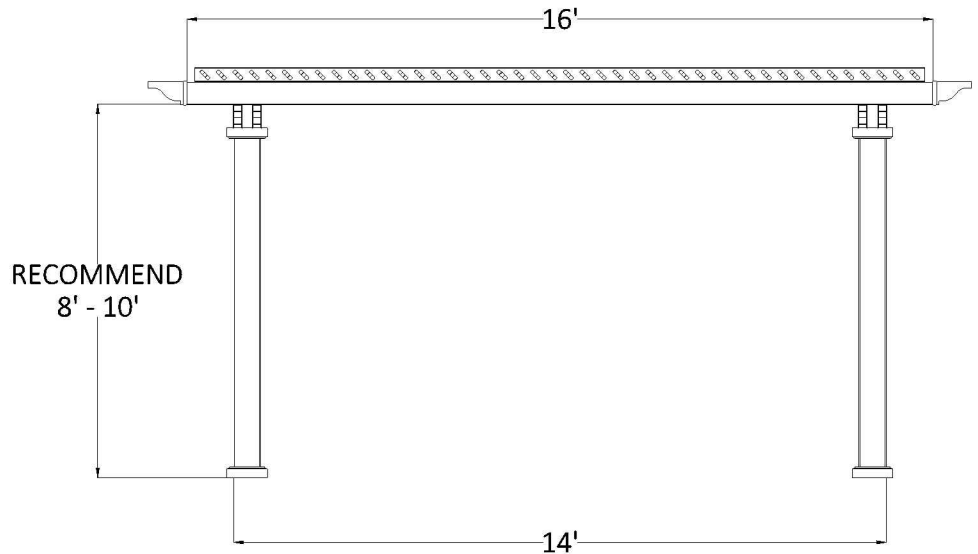

Center of Post to Structure Measurement

5" Square Post	163"
7" Square Column	157 1/2"
7" Round Column	157 1/2"
10" Round Column	155 3/4"

PLAN VIEW

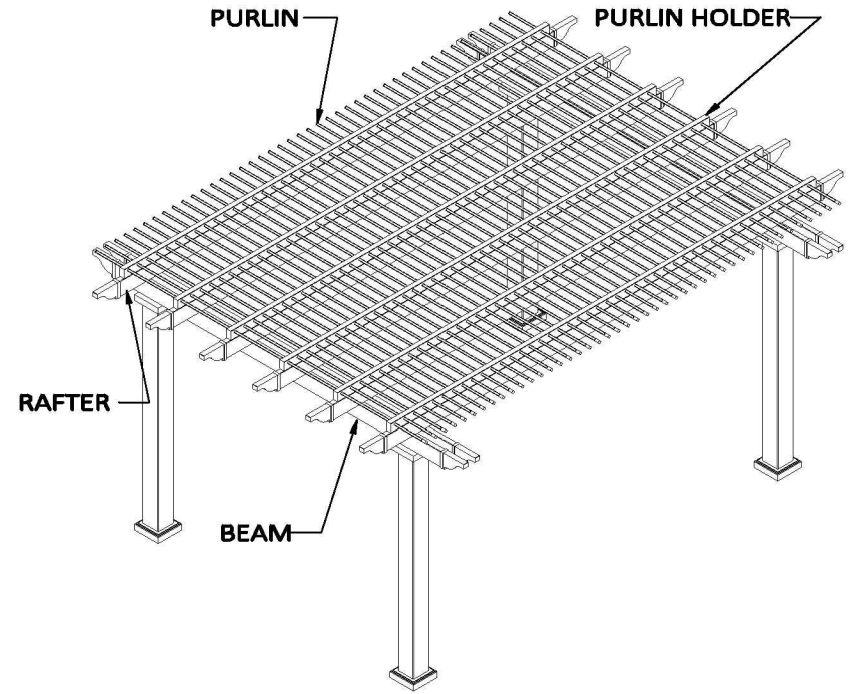
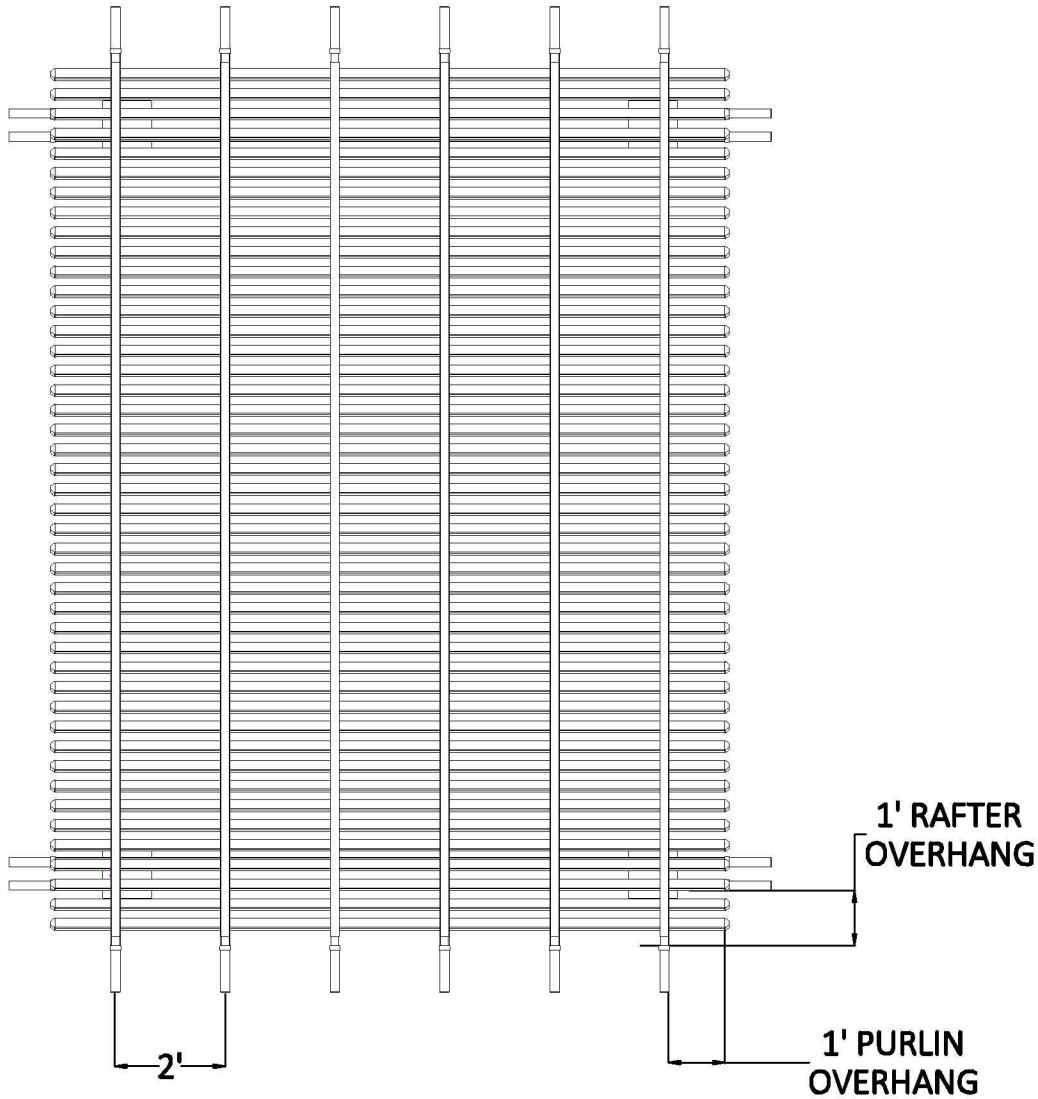

STRUCTURAL COMPONENTS

DESCRIPTION	QTY.
7" COLUMN ASSEMBLY W POST MOUNT	4
2 X 6 BEAM WITH ALUMINUM INSERT	4
2 X 6 RAFTER WITH ALUMINUM INSERT	6
2 X 6 PERGOLA CAP	20
2 X 3 1/2 PURLIN HOLDER	6
2 X 3 1/2 FLAT CAP	12
7/8 X 3 PURLIN (STD SPACING)	44
7/8 X 3 PURLIN CAP	88