

FRONT ELEVATION

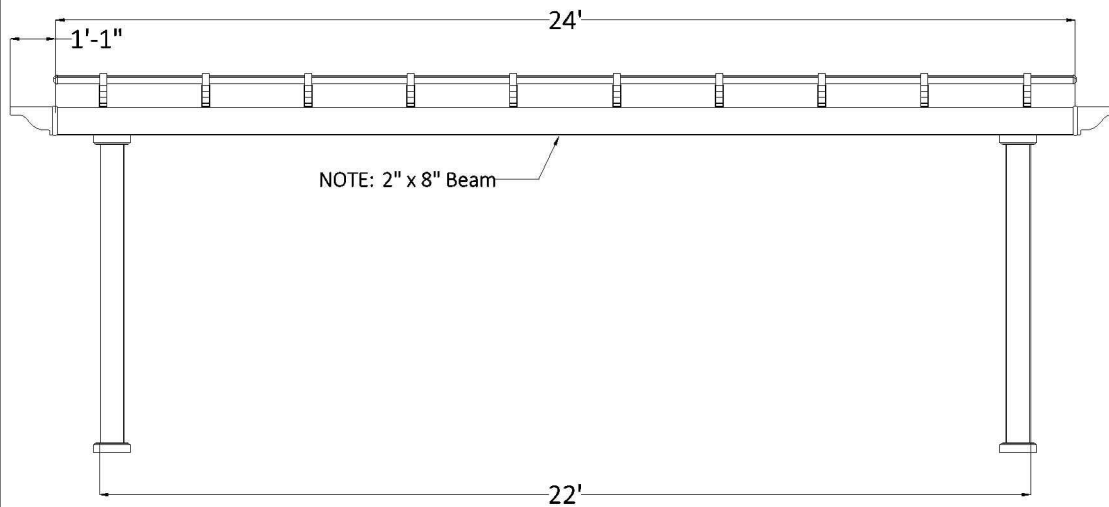

Post on Center Measurement

5" Square Post	259"
7" Square Column	253 1/2"
7" Round Column	253 1/2"
10" Round Column	251 3/4"

SIDE ELEVATION

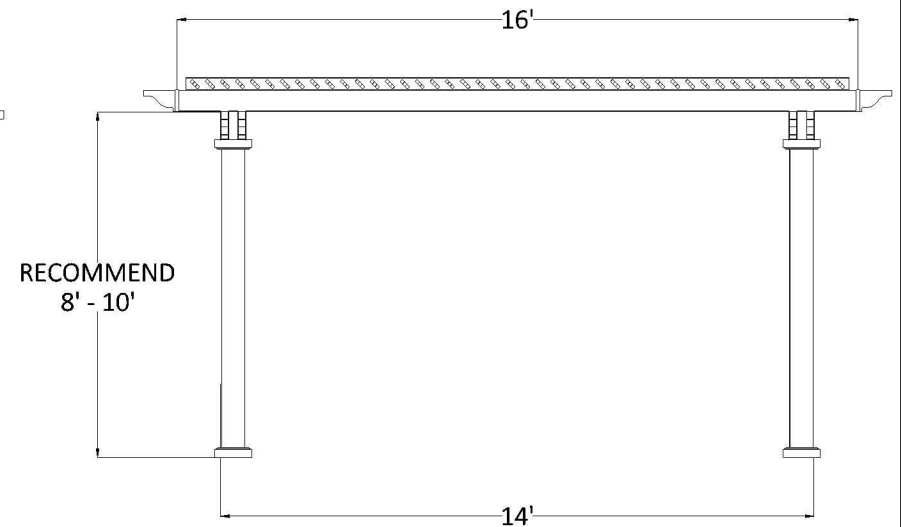

Center of Post to Structure Measurement

5" Square Post	163"
7" Square Column	157 1/2"
7" Round Column	157 1/2"
10" Round Column	155 3/4"

PLAN VIEW

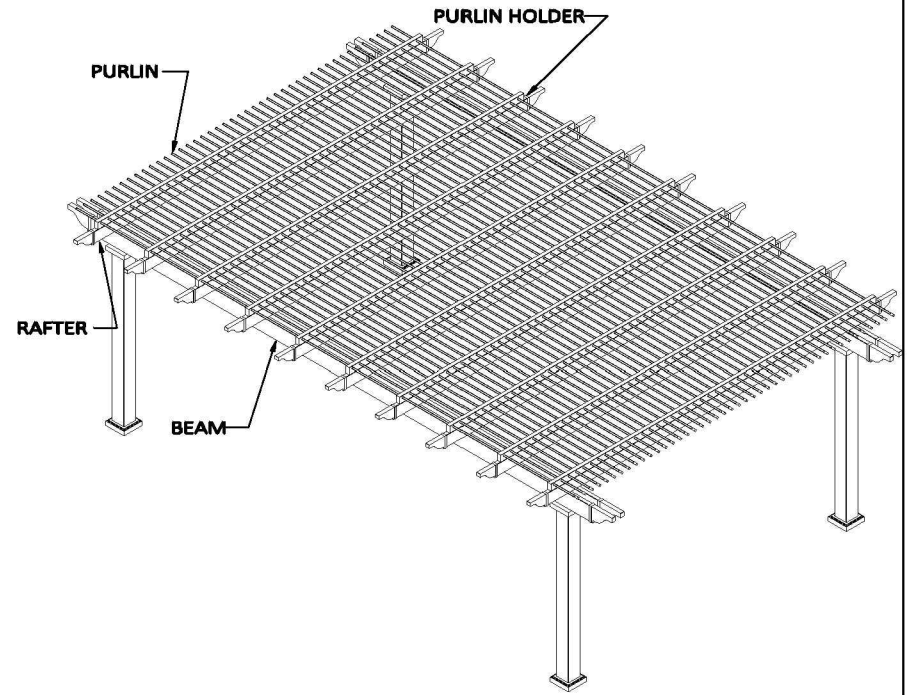
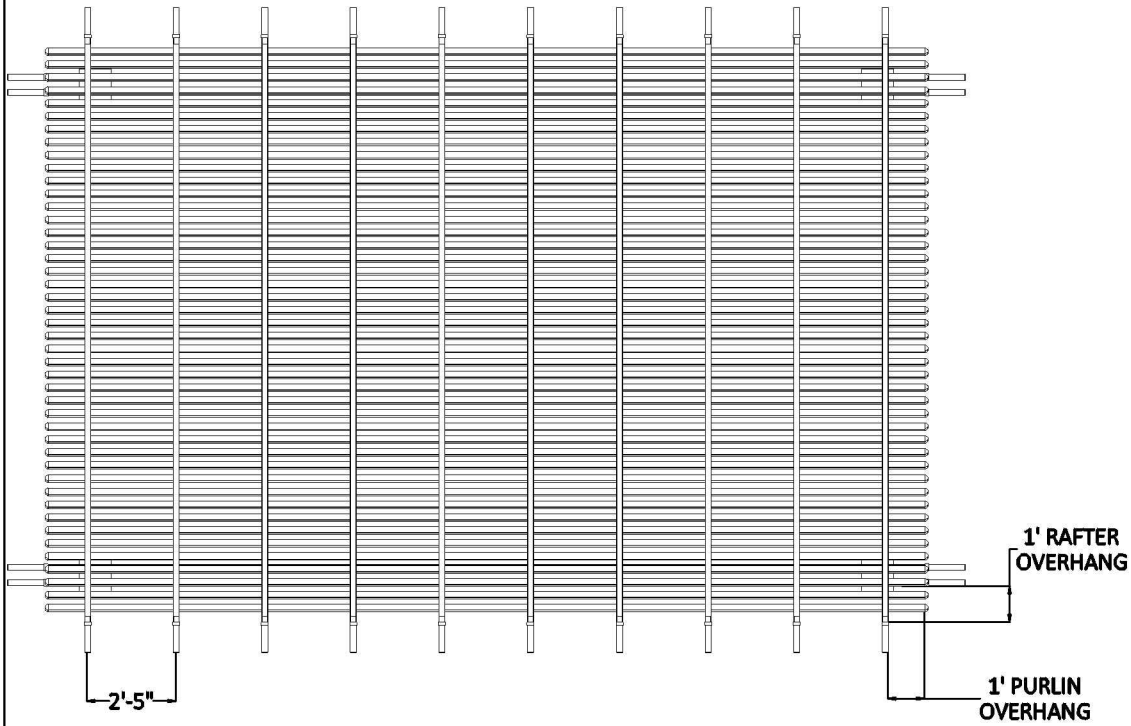

STRUCTURAL COMPONENTS

DESCRIPTION	QTY.
7" COLUMN ASSEMBLY W POST MOUNT	4
2 X 8 BEAM WITH ALUMINUM INSERT	4
2 X 6 RAFTER WITH ALUMINUM INSERT	10
PERGOLA CAP	28
2 X 3 1/2 PURLIN HOLDER	10
2 X 3 1/2 FLAT CAP	20
7/8 X 3 PURLIN (STD SPACING)	44
7/8 X 3 PURLIN CAP	88

16' x 24' FREESTANDING PERGOLA

Heartlandpergolas.com

563-345-6745

Heartland
Pergolas