

FRONT ELEVATION

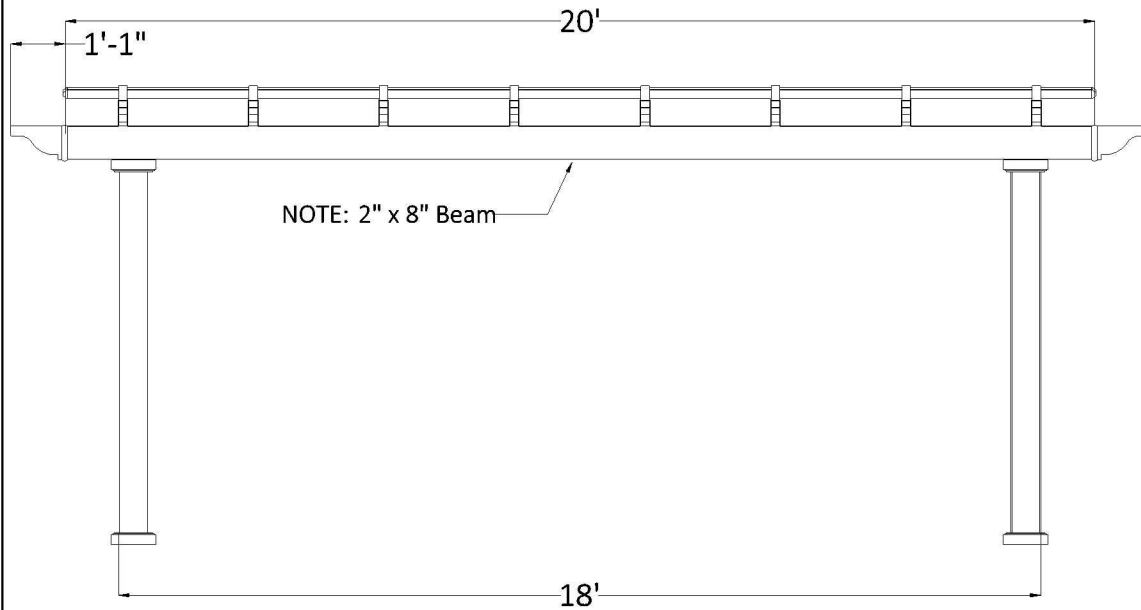

Post on Center Measurement

5" Square Post	211"
7" Square Column	205 1/2"
7" Round Column	205 1/2"
10" Round Column	203 3/4"

SIDE ELEVATION

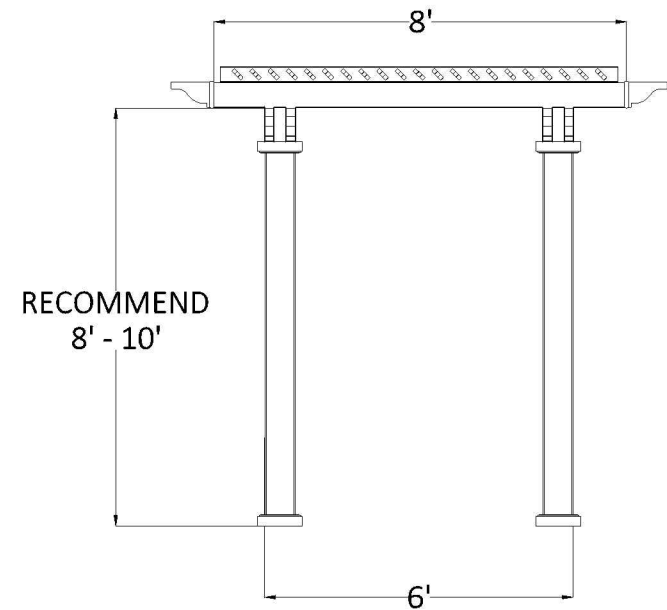

Center of Post to Structure Measurement

5" Square Post	67"
7" Square Column	61 1/2"
7" Round Column	61 1/2"
10" Round Column	59 3/4"

PLAN VIEW

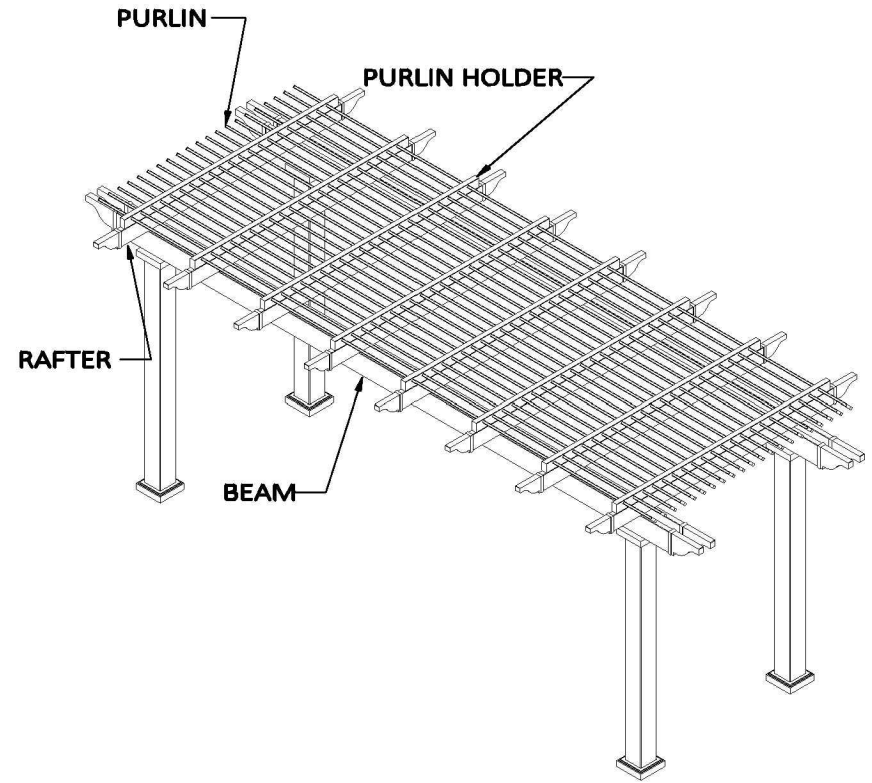
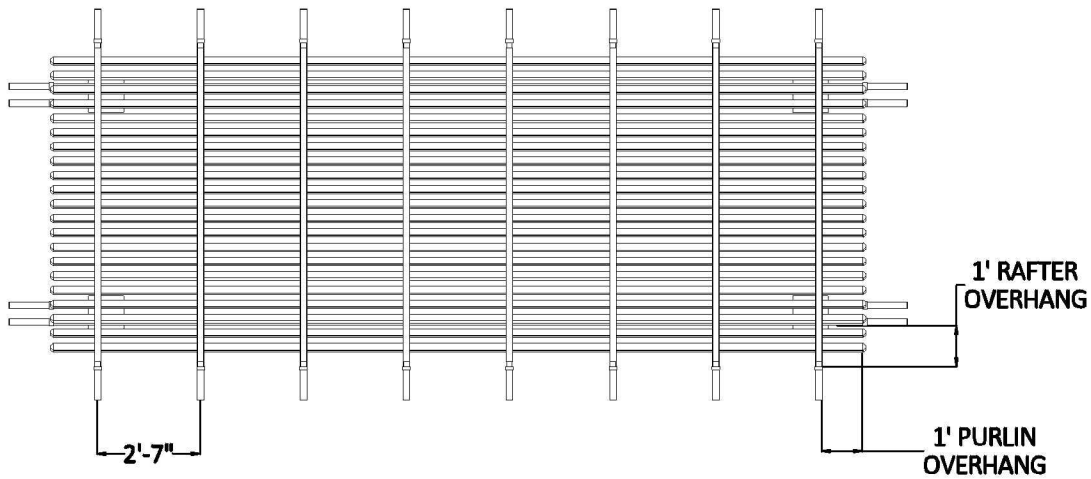

STRUCTURAL COMPONENTS

DESCRIPTION	QTY.
7" COLUMN ASSEMBLY W POST MOUNT	4
2 X 8 BEAM WITH ALUMINUM INSERT	4
2 X 6 RAFTER WITH ALUMINUM INSERT	8
PERGOLA CAP	24
2 X 3 1/2" PURLIN HOLDER	8
2 X 3 1/2" FLAT CAP	16
7/8" X 3" PURLIN (STD SPACING)	21
7/8" X 3" PURLIN CAP	42

8' x 20' FREESTANDING PERGOLA

Heartlandpergolas.com

563-345-6745

