

# FRONT ELEVATION

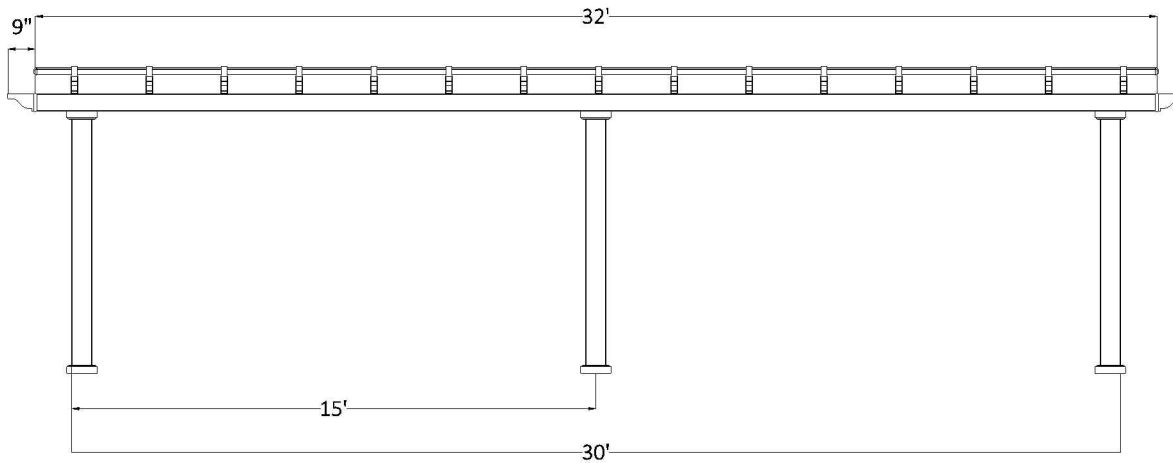

## Post on Center Measurement

5" Square Post	355"
7" Square Column	349 1/2"
7" Round Column	349 1/2"
10" Round Column	347 3/4"

# SIDE ELEVATION

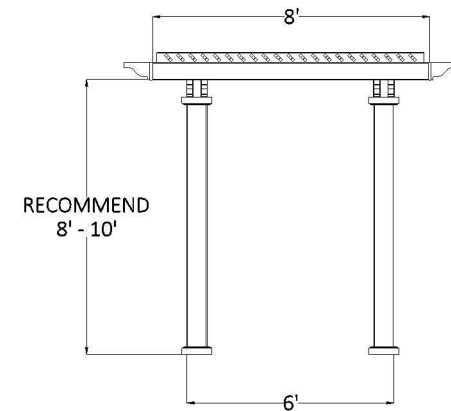

## Center of Post to Structure Measurement

5" Square Post	67"
7" Square Column	61 1/2"
7" Round Column	61 1/2"
10" Round Column	59 3/4"

# PLAN VIEW

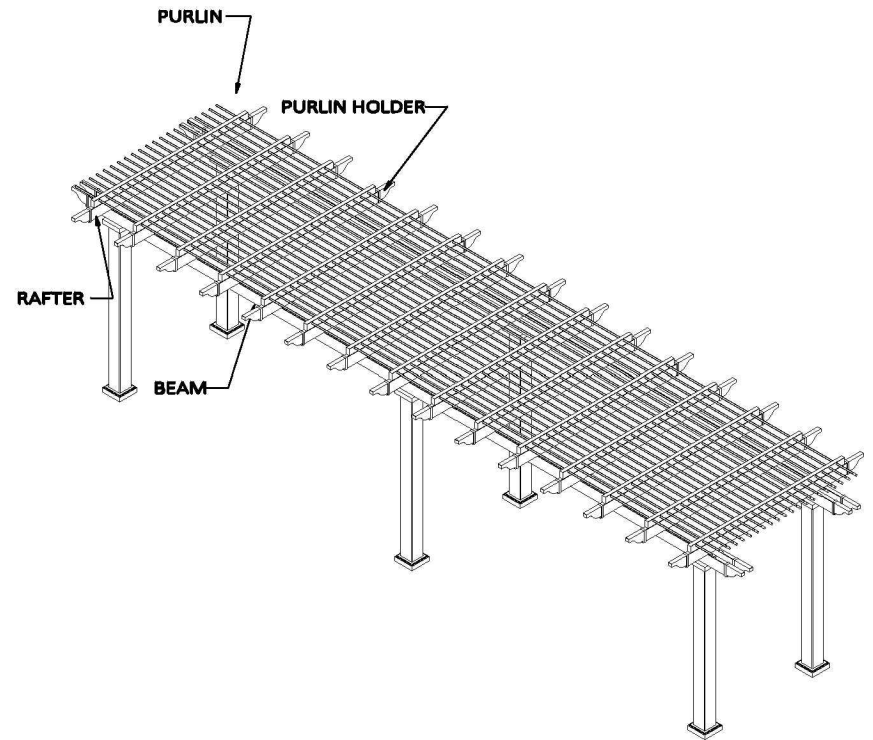
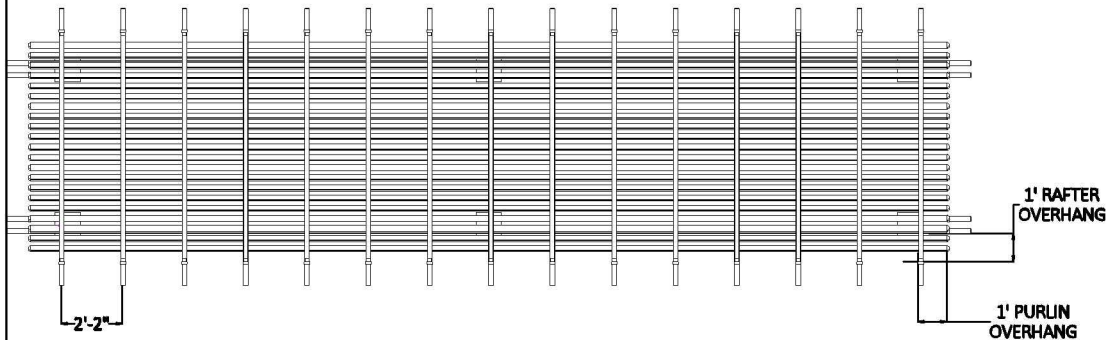

## STRUCTURAL COMPONENTS

DESCRIPTION	QTY.
7" COLUMN ASSEMBLY W POST MOUNT	6
2 X 6 BEAM WITH ALUMINUM INSERT	8
2 X 6 RAFTER WITH ALUMINUM INSERT	15
2 X 6 PERGOLA CAP	38
2 X 3 1/2" PURLIN HOLDER	15
2 X 3 1/2" FLAT CAP	30
7/8" X 3" PURLIN (STD SPACING)	21
7/8" X 3" PURLIN CAP	42

8' x 32' FREESTANDING PERGOLA

Heartlandpergolas.com

563-345-6745

**Heartland**  
Pergolas